

Article number: 2301072681

Description: E+G Handwheel
VDS.100+IR-A10

Measures

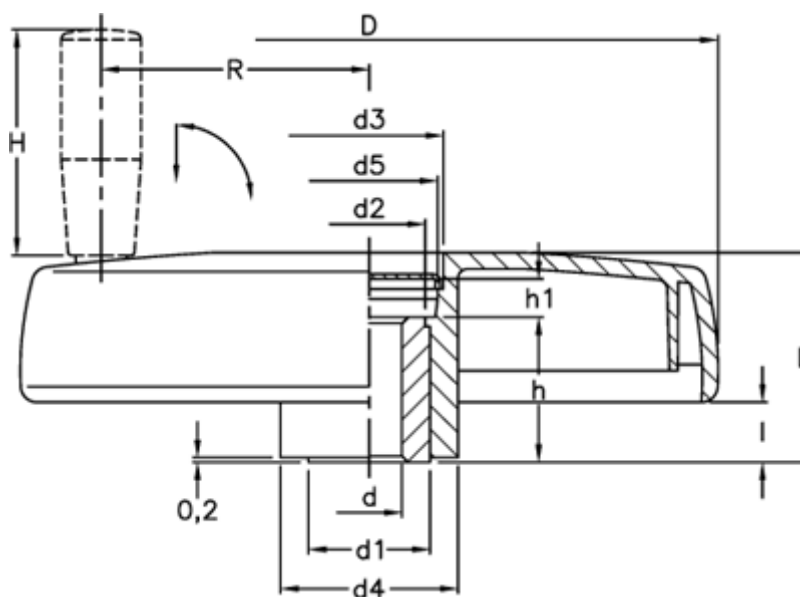

C (N m) = 60	H = 50
D = 102	h = 22
d1 = 22	h1 = 9.0
d2 = 20.0	l = 10.0
d3 = 27.0	L = 34
d4 = 30	L (J) = 14
d5 = 25.0	R = 39
d H7 = 10	